



OWNER'S MANUAL  
**KXB10 BASS GUITAR AMPLIFIER**



**Congratulations on the purchase of your new Kustom bass amplifier.**

Your KXB Model draws on decades of amp design and manufacturing experience at Kustom. This model was built from the ground up to offer world-class tone, useful features and reliable performance. Inside this manual, you'll find valuable information about the amp's controls and specifications. Being familiar with its features will help you effectively dial in different tones.

We wish you many years of enjoyment with your Kustom amplifier.

## FCC Statements

**1. Caution:** Changes or modifications to this unit not expressly approved by the party responsible for compliance could void the user's authority to operate the equipment.

**2. Note:** This equipment has been tested and found to comply with the limits for a Class B digital device, pursuant to Part 15 of the FCC Rules. These limits are designed to provide reasonable protection against harmful interference in a residential installation. This equipment generates, uses, and can radiate radio frequency energy and, if not installed and used in accordance with the instructions, may cause harmful interference to radio communications. However, there is no guarantee that interference will not occur in a particular installation. If this equipment does cause harmful interference to radio or television reception, which can be determined by turning the equipment off and on, the user is encouraged to try to correct the interference by one or more of the following measures:

- Reorient or relocate the receiving antenna.
- Increase the separation between the equipment and receiver.
- Connect the equipment into an outlet on a circuit different from that to which the receiver is connected.
- Consult the dealer or an experienced radio/TV technician for help.

# ENGLISH

## Danger

Exposure to extremely high noise levels may cause a permanent hearing loss. Individuals vary considerably to noise induced hearing loss but nearly everyone will lose some hearing if exposed to sufficiently intense noise for a sufficient time.

The U.S. Government's Occupational Safety and Health Administration (OSHA) has specified the following permissible noise level exposures:

DURATION PER DAY (HOURS)	8	6	4	3	2	1
SOUND LEVEL (dB)	90	93	95	97	100	103

According to OSHA, any exposure in the above permissible limits could result in some hearing loss. Ear plugs or protectors in the ear canal or over the ears must be worn when operating this amplification system in order to prevent a permanent hearing loss. If exposure in excess of the limits as put forth above, to insure against potentially harmful exposure to high sound pressure levels, it is recommended that all persons exposed to equipment capable of inducing high sound pressure levels, such as this amplification system, be protected by hearing protectors while this unit is in operation.

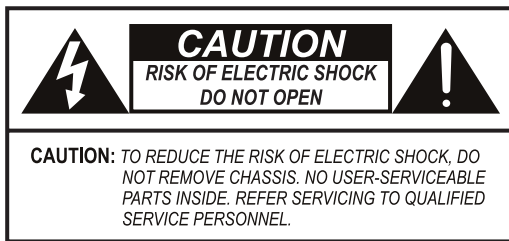

**AVIS: RISQUE DE CHOC ELECTRIQUE-NE PAS OUVRIR.**



THIS SYMBOL IS INTENDED TO ALERT THE USER TO THE PRESENCE OF NON-INSULATED "DANGEROUS VOLTAGE" WITHIN THE PRODUCT'S ENCLOSURE THAT MAY BE OF SUFFICIENT MAGNITUDE TO CONSTITUTE A RISK OF ELECTRIC SHOCK TO PERSONS.



THIS SYMBOL IS INTENDED TO ALERT THE USER TO THE PRESENCE OF IMPORTANT OPERATING AND MAINTENANCE (SERVICING) INSTRUCTIONS IN THE LITERATURE ACCOMPANYING THE UNIT.



APPARATUS SHALL NOT BE EXPOSED TO DRIPPING OR SPLASHING AND THAT NO OBJECTS FILLED WITH LIQUIDS, SUCH AS VASES, SHALL BE PLACED ON THE APPARATUS.

## IMPORTANT SAFETY INSTRUCTIONS

1. Read all safety and operating instructions before using this product.
2. All safety and operating instructions should be kept for future reference.
3. Read and understand all warnings listed on the operating instructions.
4. Follow all operating instructions to operate this product.
5. This product should not be used near water, i.e. Bathtub, sink, swimming pool, wet basement, etc.
6. Only use dry cloth to clean this product.
7. Do not block any ventilation openings, It should not be placed flat against a wall or placed in a built-in enclosure that will impede the flow of cooling air.
8. Do not install this product near any heat sources ;such as, radiators, heat registers, stove or other apparatus (including heat producing amplifiers) that produce heat.
9. Do not defeat the safety purpose of the polarized or grounding-type plug. A polarized plug has two blades with one wider than the other. A grounding-type plug has two blades and a third grounding prong. The wide blade or the third prong are provided for your safety. If the provided plug does not fit into your outlet, consult an electrician for replacement of the obsolete outlet.
10. Protect the power cord being walked on or pinched, particularly at Plugs, convenience receptacles and the point where they exit from the apparatus. Do not break the ground pin of the power supply cord.
11. Only use attachments specified by the manufacturer.
12. Use only with the cart, stand, tripod, bracket, or table specified by the manufacturer or sold with the apparatus. When a cart is used, use caution when moving cart/ apparatus combination to avoid injury from tip-over. 
13. Unplug this apparatus during lightning storms or when unused for long periods of time.
14. Care should be taken so that objects do not fall and liquids are not spilled into the unit through the ventilation ports or any other openings.
15. Refer all servicing to qualified service personnel. Servicing is required when the apparatus has been damaged in any way; such as, power-supply cord or plug is damaged, liquid has been spilled or objects have fallen into the apparatus, the apparatus has been exposed to rain or moisture, does not operate normally or has been dropped.
16. **WARNING:** To reduce the risk of fire or electric shock, do not expose this apparatus to rain or moisture.
17. When the MAINS plug is used as the disconnect device, the disconnect device shall remain readily operable.

# FRENCH

## Danger

L'exposition a des niveaux eleves de bruit peut provoquer une perte permanente de l'audition, Chaque organisme humain reagit differemment quant a la perte de l'audition, mais quasiment tout le monde subit une diminution de l'acuite auditive lors d'une exposition suffisamment longue au bruit intense. Les autorites competentes en reglementation de bruit ont defini les expositions tolerees aux niveaux de bruits:

DURE EN HEURES PAR JOUR	8	6	4	3	2	1
INIVEAU SONORE CONTINU EN dB	90	93	95	97	100	103

Selon les autorites, toute exposition dans les limites citees ci-dessus, peuvent provoquer certaines pertes d'audition. Des bouchons ou protections dans l'appareil auditif ou sur l'oreille doivent etre portes lors de l'utilisation de ce systeme d'amplification afin de prevenir le risque de perte permanente de l'audition, Dans le cas d'expositions superieures aux limites precitees il est recommande, afin de se premunir contre les expositions aux pressions acoustiques elevees potentiellement dangeereuses, aux personnes exposees aux equipements capables de delivrer de telles puissances, tels ce systeme d'amplification en fonctionnement, de proteger l'appareil auditif.



CE SYMBOLE A POUR BUT D'AVERTIR L'UTILISATEUR DE LA PRESENCE DE VOLTAGE DANGEREUX NON-ISOLE A L'INTERIEUR DE CE PRODUIT QUI PEUT ETRE DE PUISSANCE SUFFISAMMENT IMPORTANTE POUR PROVOQUER UN CHOC ELECTRIQUE AUX PERSONNES.



CE SYMBOLE A POUR BUT D'AVERTIR L'UTILISATEUR DE LA PRESENCE D'INSTRUCTIONS D'UTILISATION ET DE MAINTENANCE DANS LES DOCUMENTS FOURNIS AVEC CE PRODUIT.



AFIN DE REDUIRE LES RISQUÉ D'INCENDIE ET DE DECHARGE ELECTRIQUE, NE PAS EXPOSER CET APPAREIL A LA PLUIE OU A L'HUMIDITE.

## IMPORTANTES INSTRUCTIONS DE SECURITE

1. Lire avec attention toutes les recommandations et précautions d'emploi avant d'utiliser ce produit.
2. Toutes les recommandations et précautions d'emploi doivent être conservées afin de pouvoir s'y reporter si nécessaire.
3. Lire et comprendre tous les avertissements énumérés dans les précautions d'emploi.
4. Suivre toutes les précautions d'emploi pour utiliser ce produit.
5. Ce produit ne doit pas être utilisé près d'eau, comme par exemple baignoires, éviers, piscine, sous-sol humides ... Etc.
6. Utiliser exclusivement un chiffon sec pour nettoyer ce produit.
7. Ne bloquer aucune ouverture de ventilation. Ne pas placer le produit tout contre un mur ou dans une enceinte fermée, cela générerait le flux d'air nécessaire au refroidissement.
8. Ne pas placer le produit près de toute source de chaleur telle que radiateurs, arrivées d'air chaud, fourneaux ou autres appareils générant de la chaleur (incluant les amplificateurs producteurs de chaleur) .
9. Ne pas négliger la sécurité que procure un branchement polarisé ou avec raccordement à la terre, Un branchement polarisé comprend deux fiches dont l'une est plus large que l'autre. Un branchement à la terre comprend deux fiches plus une troisième reliée à la terre. Si la fiche secteur fournie ne s'insère pas dans votre prise de courant. consulter un 'électricien afin de remplacer votre prise obsolète.
10. Protéger le cordon d'alimentation de tout écrasement ou pincement, particulièrement au niveau des fiches, des réceptacles utilisés et à l'endroit de sortie de l'appareil. Ne pas casser la fiche de terre du cordon d'alimentation.
11. Utiliser uniquement les accessoires spécifiés par le constructeur.
12. Utiliser uniquement avec le chariot de transport, le support, le trépied, la console ou la table spécifiés par le constructeur ou vendus avec l'appareil. Lors de l'utilisation d'un chariot, bouger avec précaution l'ensemble chariot/appareil afin d'éviter les dommages d'un renversement.
13. Débrancher cet appareil lors d'orages ou s'il n'est pas utilisé pendant une longue période.
14. Des précautions doivent être prises afin qu'aucun objet ne tombe et qu'aucun liquide ne se répande à l'intérieur de l'appareil par les orifices de ventilation ou n'importe quelle autre ouverture.
15. Pour toutes interventions techniques s'adresser à un technicien qualifié. L'intervention technique est nécessaire lorsque l'appareil a été endommagé de n'importe quelle façon, comme par exemple si le cordon secteur ou sa fiche sont détériorés, si du liquide a coulé ou si des objets sont tombés à l'intérieur de l'appareil, si l'appareil a été exposé à la pluie ou à l'humidité, s'il ne fonctionne pas normalement ou s'il est tombé.
16. ATTENTION: Pour réduire le risque d'incendie ou de choc électrique ne pas exposer l'appareil à la pluie ou à l'humidité.
17. Quand la prise MAINS est utilisé pour la source d'alimentation électrique, il est conseillé de garder cette prise facilement accessible.



# KXB10 Control Panel

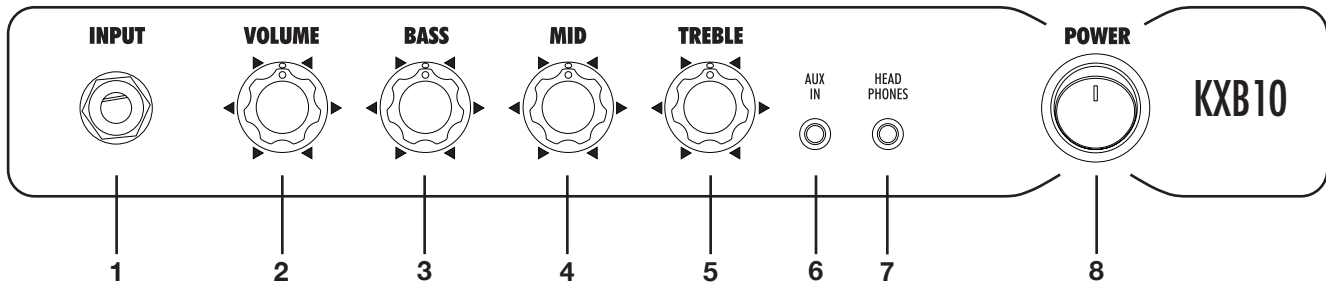

- 1. Input Jack:** 1/4-inch input that is intended for bass guitar but will accept other instruments as well.
- 2. Volume:** Adjust this control to set the desired volume level of the amplifier. **Note:** If you are using an instrument with a built-in active preamp, set its level to mid-position before increasing its volume or distortion may occur.
- 3. Bass:** This control adjusts the lower frequencies to provide rich, full tones. It will boost or cut by 15 dB at 60 Hz.
- 4. Mid:** This control adds a thick, punchy quality to your tone. It will boost or cut by 15 dB at 500Hz.
- 5. Treble:** Increasing this control will add presence and attack to your bass tone. It will boost or cut by 15 dB at 10 kHz.
- 6. Aux In:** This is a 3-conductor, 1/8-inch, stereo jack that allows playback from a Compact Disc, MP3 player or other audio device. The overall volume level will be determined by the audio device, so start with lower volume levels and increase as needed.
- 7. Headphones:** This is a 3-conductor, 1/8-inch input jack intended for headphone use. The amplifier's internal speaker is disconnected when this jack is used.
- 8. Power Switch:** This dual-function component is both an On/Off power switch and a status indicator light. When illuminated, it shows that your amplifier is ready to be played. To turn amplifier on, press switch upward. To turn amp off, press switch downward.

# KXB10 Back Panel



**Power Cord:** This supplies AC power to the amplifier. If the cord becomes damaged, take the amplifier to an authorized service center for repair.

# KXB10 Suggested Settings

The following suggested settings will help you dial in a variety of popular tones. Keep in mind, these are starting points to get you up and running with your KXB amplifier. Feel free to experiment to achieve your own signature sounds.

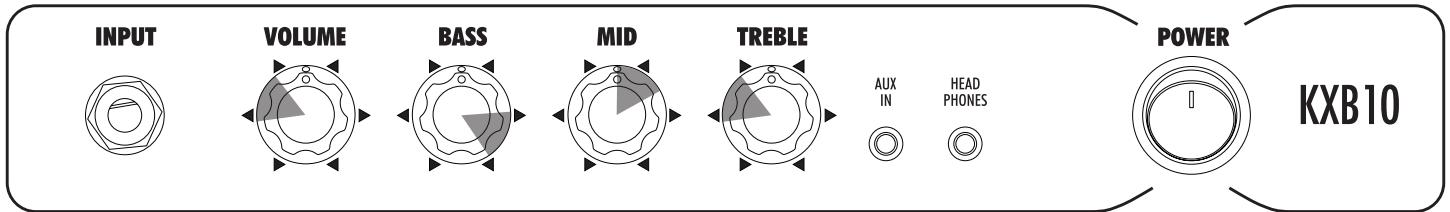

## TRADITIONAL/VERSATILE TONE

In this setting, the amplifier will deliver a traditional, yet versatile, electric bass sound. Whether you are playing Rock, Country, Blues or Gospel, this setting will get you close. If you play with a pick and want less treble attack on the notes, decrease the amount of high frequencies using the Treble control. If you need a deeper bottom end, increase the amount of low frequencies using the Bass control. Adjust the amount of Midrange to best match the tone of your bass guitar and how it fits into the overall sound.

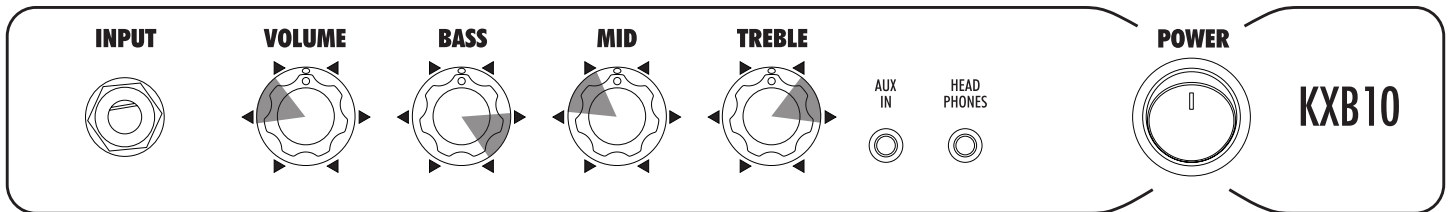

## FUNKY, SLAPPED TONES

This style of music needs a strong attack with lots of treble content. Using less Midrange will produce the extra top end necessary for this type of music. If you use a “slapping” thumb technique, add a bit more low end and extra volume – or less if you really hit the strings hard. Even though this is a practice or rehearsal-level amplifier, it will deliver the punch and clarity that you require.

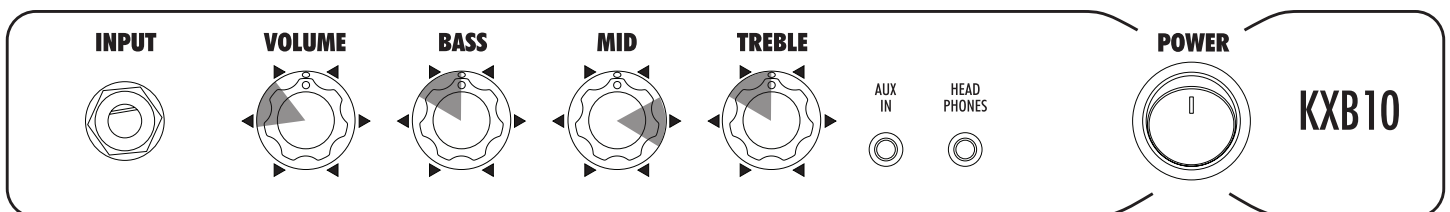

## ALTERNATIVE STYLE

These settings are designed for upper-end punch and edge that will cut through most any sound mix. This tone will work well with pick or fingers. Make sure your bass guitar’s volume control is up all the way. Since you’re adding volume, be careful with the amount of Bass, Mid and Treble that you dial in, as it can also add some distortion to the sound.

## Kustom® KXB10 Specifications

<b>Output Power</b>	10 Watts	4 Ohms at 10% THD+N
<b>Speaker</b>	1 X 10"	Custom Designed 4 Ohms
<b>Input Impedance</b>	Single Input	470K Ohm
<b>Gain</b>	48 dB	Volume @ Max, All EQ at 12 o'clock
<b>S/N Ratio</b>	-80 dB typical	Below rated power
<b>Aux Input</b>	800 mV Sensitivity	Stereo 3.5mm High Impedance
<b>Headphone Output</b>	10 mW @ 30 ohms per channel	Stereo 3.5mm
<b>Amplifier Tone Controls</b>	60 Hz	+/- 15 dB
	500 Hz	+/- 15 dB
	10 Hz	+/- 15 dB
<b>Power Requirements</b>	USA/Canada	120VAC/60Hz, 25W
	Europe	230VAC/50Hz, 25W
	UK	240VAC/50Hz, 25W
	Australia	240VAC/50Hz, 25W
	Japan	100VAC/50-60Hz, 25W
<b>Dimensions/Weight</b>	cm <sup>3</sup> /Kilogram	44.5 (Height) X 35.1 (Width) X 26.4 (Depth), 10.4 Kilogram
	Inches/Pounds	17.5 (Height) X 13.8 (Width) X 10.4 (Depth), 23 Lbs



# KXB10 SIGNAL FLOW DIAGRAM

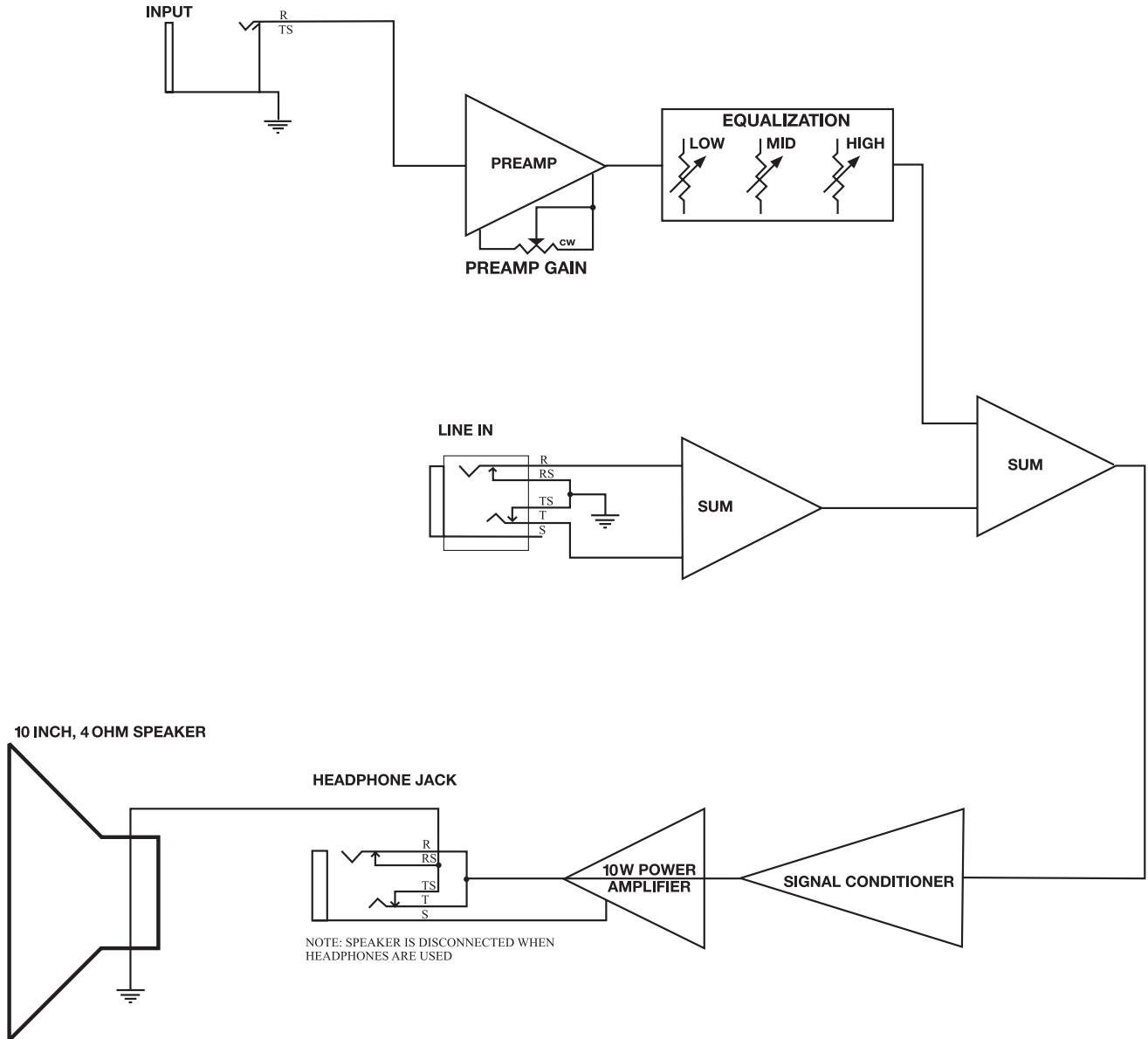

# EC Declaration of Conformity

We: Kustom Musical Amplification Inc.  
3015 Kustom Drive  
Hebron, Ky 41048-0568  
Tel: 1-859-817-7100 Fax: 1-859-817-7150

Declare that the product

Product name: Kustom

Product model number: KXB10

to which this declaration relates is in conformity with the following standards;

EN55013 (A12): 1995	Limits and methods of measurement of radio disturbance characteristics of broadcast receivers and associated equipment.
EN55020: 1995	Electromagnetic immunity of broadcast receivers and associated equipment.
EN61000-3-2: 1995	Limits for harmonic current emissions (equipment input current $\leq 16\text{A}$ per phase).
EN61000-3-3: 1995	Limitation of voltage fluctuations and flicker in low voltage supply systems for equipment with rated currents $\leq 16\text{A}$ .
EN55103-1: 1995	Electromagnetic Compatibility - Product family standard for Audio, Video Audio-visual and entertainment Lighting Control Apparatus.
EN60065: 1994	Safety requirements for main operated electronic and related apparatus for household and similar general use.

Following the provisions of EU Council Directive(s): 72/73 EEC and 89/336/EEC.

We the undersigned, hereby declare that the equipment specified above conforms to the aforementioned directive(s).

Name of authorized person: James Brown, Chief Engineer

Signature: 

Date: 19 November 2009

Kustom Musical Amplification Inc.  
3015 Kustom Drive  
Hebron, Ky 41048-0568  
Tel: 1-859-817-7100 Fax: 1-859-817-7150





[www.kustom.com](http://www.kustom.com)

Kustom Amplification, Inc.  
3015 Kustom Drive  
Hebron, Kentucky  
USA 41048  
888-4-KUSTOM (888-458-7866)

All specifications are subject to change without prior notice. ©2010 Kustom

